

Product Specification

HOP-TRB-C03 Ver: 3.1

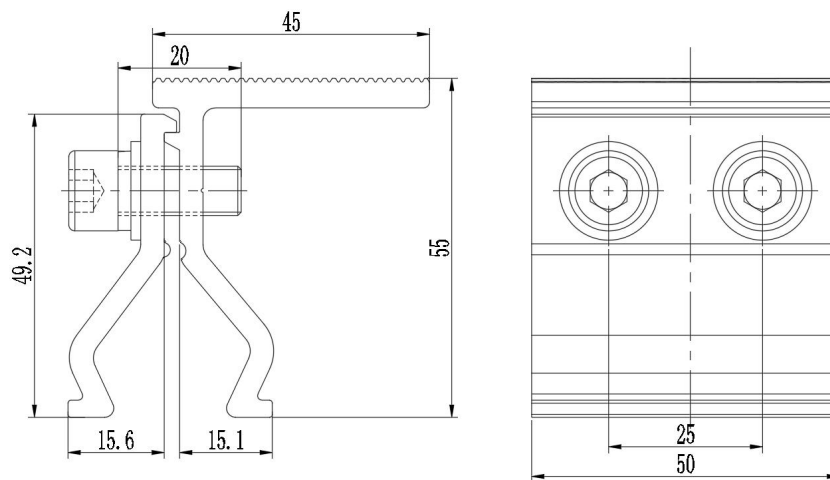

Name	Tin Interface Bracket #3
Stock Code	TRB-C03
Weight(g)	118
BOM	HOP-H10-0050 (AL6005-T5) x 1
	HOP-H11-0050 (AL6005-T5) x 1
	M8*20 Hexagon socket head cap screws (SUS304) x2
	d8 plain washers(SUS304) x2 d8 Spring washers (SUS304) x 2
Packing	170pcs
Carton size	540×220×200